

REACH/IIZSIPX7

CAD GENERATED DRAWING. DON'T CHANGE BY HAND.

| | | |
|------|----------|-------|
| REV. | ECN. NO. | APPD. |
| | | |

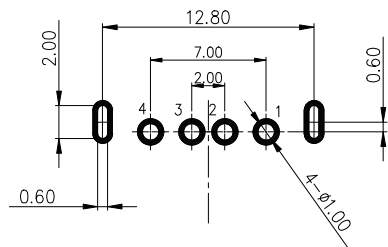
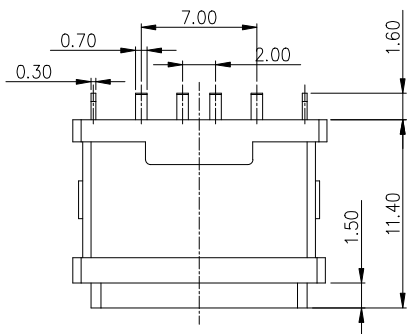

RECOMMENDED PCB LAYOUT(TOP VIEW)

THICKNESS T=1.0mm
DEFAULT TOLERANCE+/-0.05

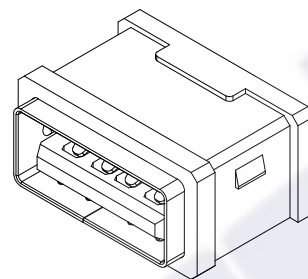

NOTES:
SPECIFICATION:

1. CURRENT RATING: 3.0A MAX
2. DIELECTRIC WITHSTAND VOLTAGE: 100VAC
3. TEMPERATURE RANGE: -30 °C ~ 85 °C
4. CONTACT RESISTANCE: 40 MILLIONHM MAX
5. INSULATION RESISTANCE: 100 MEGOHMS MIN.
6. INSERTION FORCE : 10N~30N
7. UNMATING FORCE: 8N~30N
8. DURABILITY: 1500 CYCLES

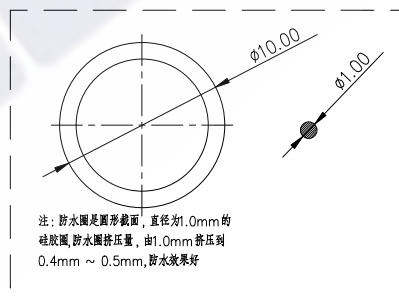
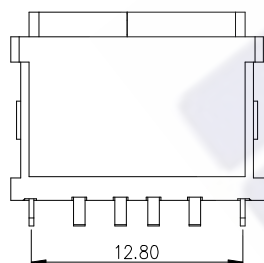
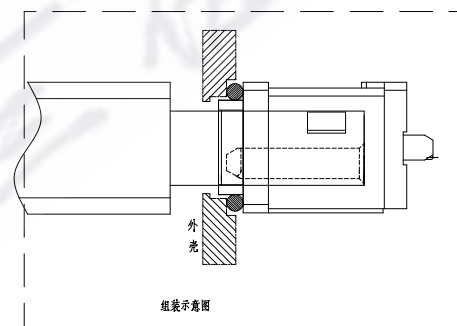
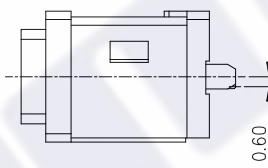
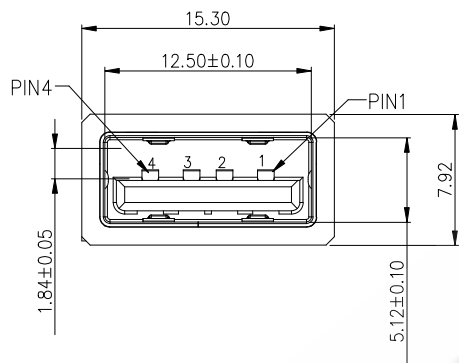

PIN ASSIGNMENT

| | | | | |
|-------------|------|----|----|-----|
| PIN NO. | 1 | 2 | 3 | 4 |
| SINGAL NAME | VBUS | D- | D+ | GND |

| 4 | Shell | 1 | SUS 301 1/4H | |
|--|---------------|-------------|--|-------------------------------------|
| 3 | PLASTIC Shell | 1 | PA10T (G.F30%) | |
| 2 | Contact | 4 | BRASS C2680-EH Au/Ni Plating T=0.25mm | |
| 1 | Housing | 1 | PA10T (G.F30%) | |
| ITEM | PART NAME | Q'TY | FINISH | NOTE |
| .X | ± 0.50 | .X.' ± 2' | UNITS mm | 三佐部品【中国】股份有限公司 |
| .X | ± 0.30 | .X' ± 1' | | |
| .XX | ± 0.10 | .XX' ± 0.5' | | |
| .XXX | ± 0.05 | | | |
| The copyright belongs to samzo parts [China] Co., Ltd. please use the material after samzo parts agree to authorize. The final right of interpretation belongs to samzo parts. | | | FINISH | PART NO. MTKHFO4LD1ADWNPP |
| | | | Q'TY | TITLE: WATERPROOF USB 2.0 A TYPE |
| | | | APPD: | DWG NO.: MTKHFO4LD1ADWNPP |
| | | | CHKD: | |
| | | | DR: JANE CHOU 2021/10/20 | |
| | | | | SCALE SHEET REV. 1/1 1/2 A1 |