

版次 (REV)	变更编号 (ECN NO)	说明 (DESCRIPTION)	日期 (DATE)	核准 (APP)
X1		初版发行		

新材料 1024AO-****

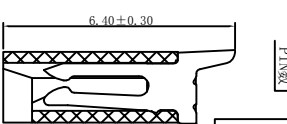
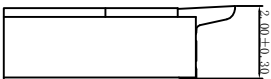
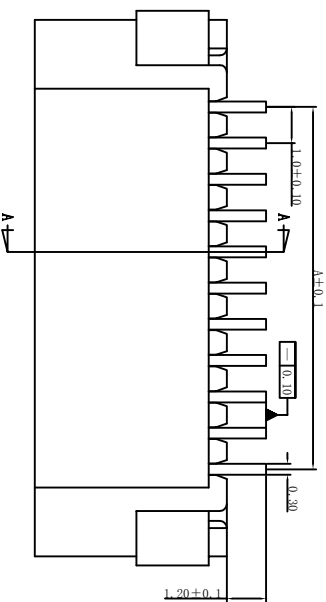

- 1: LCP 2: PA9T
 D: 袋装 G: 管装 P: 盘装
 1: 零件 2: 壳模 3: 镀金

旧料号 88358-XXXX

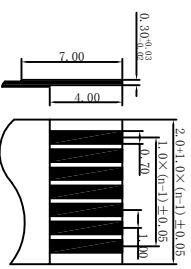
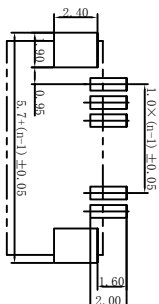
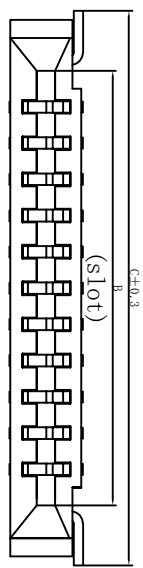
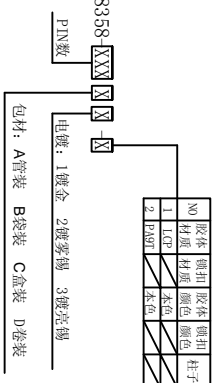

Electrical
 Voltage: 50 V AC(rms)/DC
 Current: 0.5 A AC(rms)/DC
 Contact Resistance: 40 mΩ max (Initial)
 Dielectric Withstanding Voltage: 200 V AC/rms
 Insulation Resistance: 800 MΩ min
 Operating Temp: -25° C~+85° C

No. of Connectors (n)	Dimensions		
	A	B	C
004	3.0	5.1	8.3
005	4.0	6.1	9.3
006	5.0	7.1	10.3
007	6.0	8.1	11.3
008	7.0	9.1	12.3
009	8.0	10.1	13.3
010	9.0	11.1	14.3
011	10.0	12.1	15.3
012	11.0	13.1	16.3
013	12.0	14.1	17.3
014	13.0	15.1	18.3
015	14.0	16.1	19.3
016	15.0	17.1	20.3
017	16.0	18.1	21.3
018	17.0	19.1	22.3
019	18.0	20.1	23.3
020	19.0	21.1	24.3
021	20.0	22.1	25.3
022	21.0	23.1	26.3
023	22.0	24.1	27.3
024	23.0	25.1	28.3
025	24.0	26.1	29.3
026	25.0	27.1	30.3
027	26.0	28.1	31.3
028	27.0	29.1	32.3
029	28.0	30.1	33.3
030	29.0	31.1	34.3
031	30.0	32.1	35.3
032	31.0	33.1	36.3

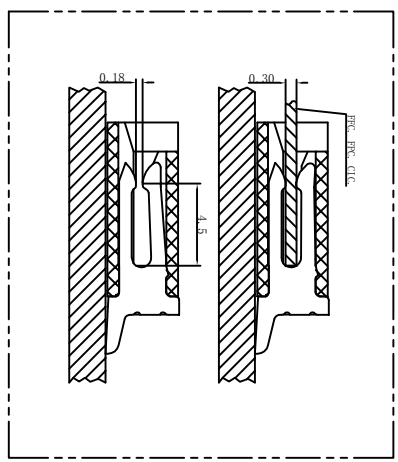

使用类别 (EXTEND USE)	品名 (TITLE)	图号 (DWG NO):	
PFC1.0贴无盖双面接 (带焊片)	PFC1.0贴无盖双面接 (带焊片)	1024AO	
尺寸公差	数量 (QTY)	料号 (P/N):	图例 (SCALE)
±0.30	数量 (QTY)	1024AO-***-***	比例 (SCALE)
±0.20	表面处理 (FINISHED)		1:1
±0.10			
±0.05			
角度公差	审核 (CHK)	绘图 (DRW)	
±3°	核准 (APP)	安路路	2014.6.28
±2°			
±1°			

三佐部品